

CONCORD TRANSFORMER PRO

变形金刚

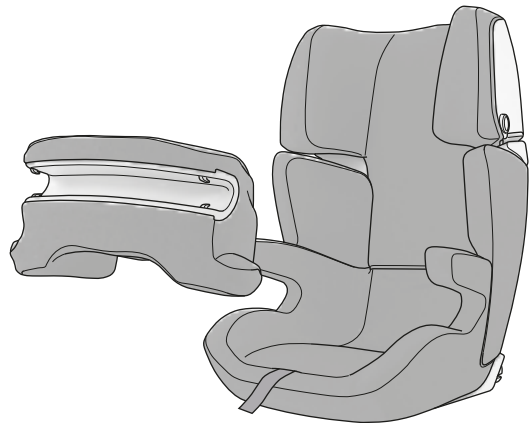

中文
ENGLISH

03
29

执行标准：GB27887-2011 《机动车儿童乘员用约束系统》



德国工业标准 ECE R44 04
standard ECE R44 04



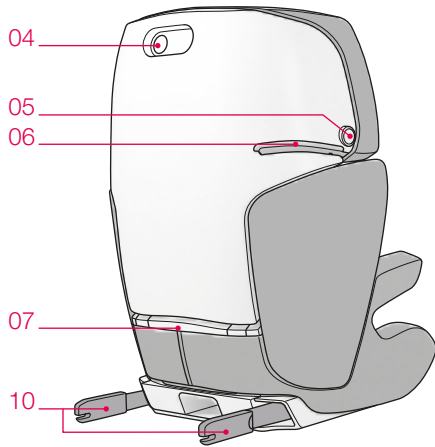
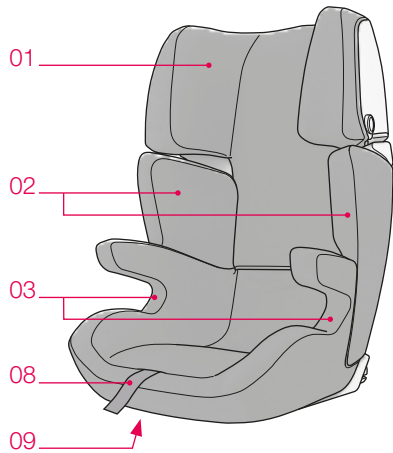

儿童体重 9 kg - 18 kg
 child's weight 9 kg - 18 kg
 年龄范围 9个月 - 4岁
 approx. age 9 months - 4 years
 质量组 I
 ECE group I



儿童体重 15 kg - 36 kg
 child's weight 15 kg - 36 kg
 年龄范围 3-12 岁
 approx. age 3 - 12 years
 质量组 II / III
 ECE groups II / III



_ 中文

概述	04
感谢	06
须知	07
使用CONCORD TRANSFORMER PRO	10
安装CONCORD TRANSFORMER	11
安装带TWINFIX 的CONCORD TRANSFORMER	12
卸除带TWINFIX 的CONCORD TRANSFORMER	14
TWINFIX适用的车辆	15
使用CONCORD 护体（适用9至18公斤）	16
CONCORD 护体的护理	19
使用三点式安全带保护儿童（适用15至36公斤）	20
基本说明	23
面套护理	24
保修	26
CONCORD 原装备件/附件	27

_ 概述

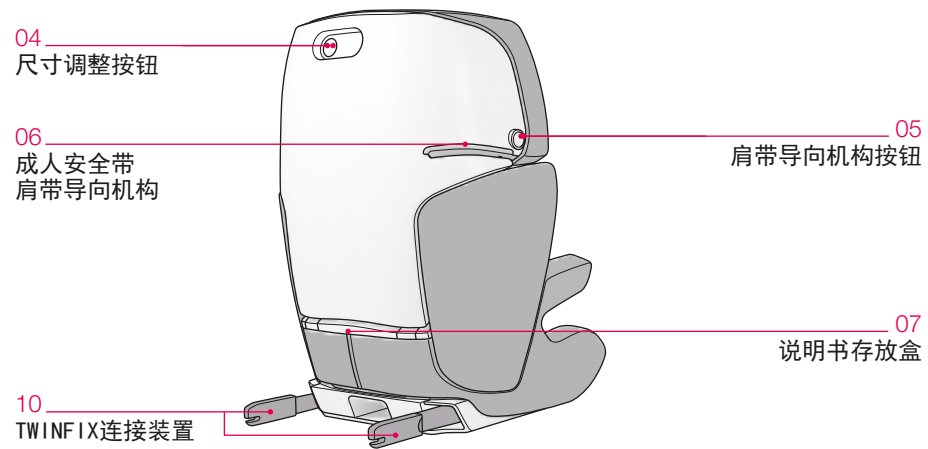
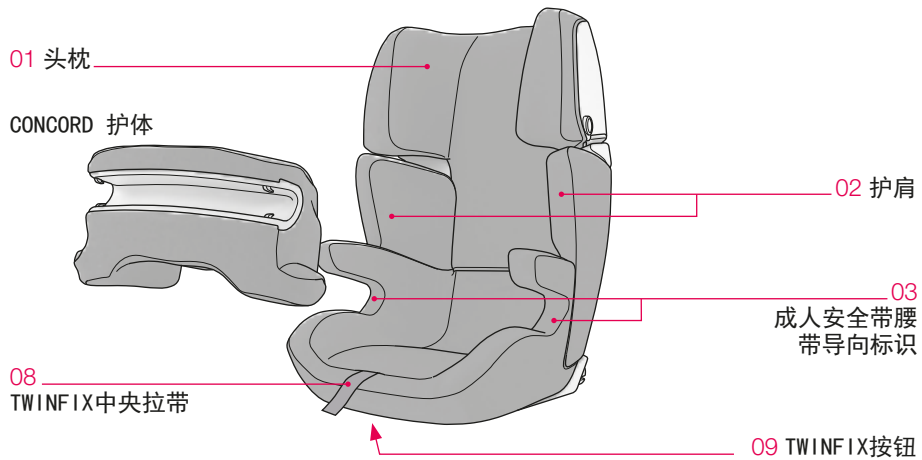

_ 感谢!

感谢您选择了Concord优质产品。这款产品的适用性和安全性一定会赢得您的信赖。愿您使用愉快。

_ 须知

注意!

- 在使用前请仔细阅读本说明书，并且请妥善保存供以后参照。如果不按照本说明书可能会影响儿童的安全。同时必须遵守汽车说明书中有关儿童乘坐的注意事项。

警告!

- 不要将儿童在无人照看的情况下放置在儿童约束系统内。
- 儿童有时会在衣服或裤子口袋中放东西(如玩具)，或穿戴带有硬物(如带扣)的衣服。一定要保证这些物品不要夹在儿童与安全带之间——发生事故时这些物品可能会造成不必要的伤害。成年人也会发生这种情况!
- 儿童天性活泼好动。因此，你应该耐心向孩子解释使用儿童约束系统的重要性。必须使儿童明白，不可以乱动安全带，不要打开带扣。
- 只有在本儿童安全座椅正确安装和使用的情况下，儿童的安全才能得到最大的保障。
- 儿童约束系统的每条与车辆连接的织带应系紧，约束儿童的织带应根据儿童的身体进行调整，织带不得扭曲。
- 如果儿童约束系统的表面覆盖层不是纺织物，请远离阳光照射，否则座椅表面会烫伤儿童皮肤。
- 必须按照说明书放置和安装刚性部分和塑料部件，以确保在正常的车辆使用中，儿童约束系统不被车里的活动座椅或车门卡住。

- 没有认证许可的产品和经过改装的产品是危险的，并且附近没有制造商提供的安装说明也是很危险的。请将说明书保存在说明书存放盒中。
- 当遭受剧烈的事故后，约束系统应更换。
- 你应该告诉乘客在发生意外或事故时移走儿童的方法。
- 在碰撞事故中易造成伤害的行李和物品应被妥善安放。
- 只有在适用车型配备了通过GB14166或 ECE R16 要求的3点式安全带情况下才适用。
- 腰带非常重要，要保证腰带佩戴时能很好地约束骨盆部位。
- 没有面套的儿童约束系统不能使用；系统面套必须使用Concord认可的配件。面套材料影响儿童约束系统总体的性能。
- 不可以使用除标示出的以外的任何其它受力点。
- 仅可使用Concord认可的原装配件。否则，所有的保修及赔偿要求失效。

由于CONCORD TRANSFORMER PRO的使用周期很长，面套和其他使用过的部件自然会根据使用时间长短和频率而受到不同程度的磨损，必须更换。因此，不可能为易损件提供超出六个月的质保期。如需购买，请联系当地的婴童用品专卖店、百货商店专柜、汽车配件中心或邮购公司。在这些地方有可能买到CONCORD儿童安全座椅的全系列配件。

汽车安全带扣具不得位于成人安全带腰带导向标识的边缘上方。对此如有疑问或仍不确定，请与CONCORD取得联系。成人安全带的路径必须经过使用说明规定的儿童约束系统的接触点和部位。不得按任何其他路径安装安全带。

如果所用的车辆座椅前面有气囊，建议车辆座椅的位置要尽量向后。对于具有正面和侧面气囊的汽车来说，安装儿童约束系统时必须遵守汽车使用说明中的要求。成人安全带肩带必须从车辆肩带固定点向前穿过成人安全带肩带导向机构(06)。如有必要可调节车辆座椅位置。

_ 使用CONCORD TRANSFORMER PRO

为了孩子的安全，你购买了CONCORD TRANSFORMER PRO儿童安全座椅。本产品是在严格的质量控制下制造的。只有正确使用才能最大程度地发挥本产品的安全效能，所以你一定要严格遵守以下安装和使用要求。

本儿童约束系统可以在配备了通过GB 14166或ECE R16 要求的3点式安全带的车辆座椅上使用。统计数据表明，副驾驶座位后的座位是汽车上最安全的位置。

面套是重要部件之一，严重影响儿童约束系统总体的性能。因此，本座椅只能使用原厂面套！

_ 安装CONCORD TRANSFORMER

面向行驶方向，把CONCORD TRANSFORMER放在车辆座椅或长条座椅上面。CONCORD TRANSFORMER要与汽车座椅保持对齐。在具有标准头枕的汽车中，可以调整或取下头枕，使安装儿童座椅更方便。请注意，当取下儿童安全座椅，成年人乘车时，汽车头枕必须安装并调整好。



即使儿童安全座椅上没有儿童，在没有妥善固定的情况下，将儿童安全座椅放置在汽车上也是不安全的。否则在旅途中或发生意外时，乘客有可能受伤。因此，行驶过程中要用安全带固定好。



_ 安装带TWINFIX 的CONCORD TRANSFORMER

按下TWINFIX按钮(09)，同时完全拉出儿童安全座椅背后的TWINFIX连接装置(10)。

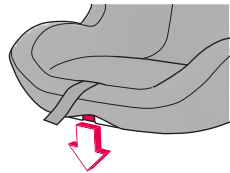

面向前方把CONCORD TRANSFORMER放在配备ISOFIX固定装置的车辆座椅或长条座椅上。

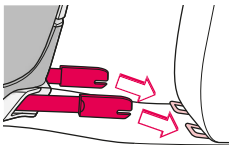
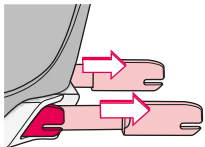

将TWINFIX连接装置(10)推向汽车中的ISOFIX固定装置，直至锁止机构发出咔嗒声(表示锁止到位)。

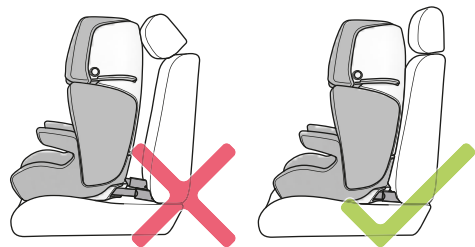
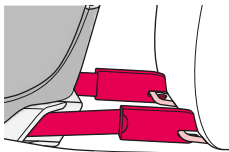

向前拉TWINFIX中央拉带(08)，推动CONCORD TRANSFORMER向后移动，直至儿童安全座椅尽量靠近汽车座椅靠背或与之保持紧贴。

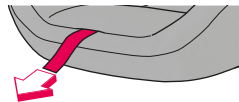

在具有标准头枕的汽车中，为了方便儿童安全座椅的安装，可以调整或取下头枕。请注意，移除此儿童安全座椅，成年人乘车时，汽车头枕必须安装并调整好。

注意!

- TWINFIX是固定CONCORD TRANSFORMER用的附加配合装置，不能约束儿童。
- 儿童必须用车辆的成人安全带约束。

卸除带TWINFIX 的CONCORD TRANSFORMER

拆卸CONCORD TRANSFORMER时，按压TWINFIX按钮(09)，将儿童安全座椅拉到最前端。

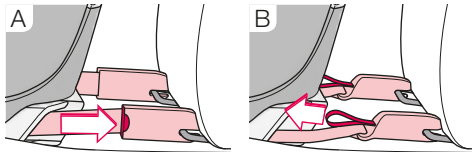

拉红色拉带，打开TWINFIX连接装置(10)上的锁止机构，安全钩会打开，并且TWINFIX连接装置会脱出。

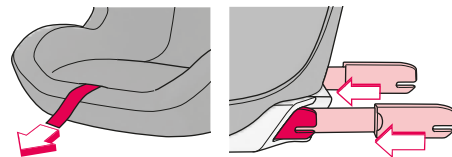

向前拉出TWINFIX中央拉带(08)，直至TWINFIX连接装置(10)完全缩回。

你还可以用手将TWINFIX连接装置(10)继续向儿童安全座椅底座里面推。

TWINFIX适用的车辆

要了解适用于CONCORD TWINFIX系统的车辆及车辆座椅，请参考《TWINFIX适合安装车辆清单》

如果没有列出你的汽车型号，购买前，请确认CONCORD TRANSFORMER可以正确地安装在你的车辆座椅上！
请认真阅读汽车厂家提供的用户手册以及本用户手册中的安装和安全事项。

最新更新请访问www.concord.de。

使用CONCORD 护体（适用9至18公斤）

P1 挡点

P2 安全带导向槽

P3 固定翼

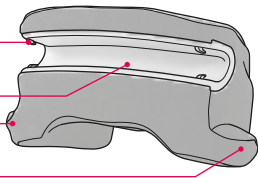

警告！

- CONCORD 护体仅可用于CONCORD TRANSFORMER PRO。
- 小孩长到约4岁或15公斤重之后，CONCORD TRANSFORMER PRO可以在没有CONCORD 护体的情况下使用。

按用户手册说明将CONCORD TRANSFORMER 安装在车辆座椅上。

让您的孩子坐进CONCORD TRANSFORMER 的座椅中，尽可能靠近靠背。

将CONCORD 护体放在CONCORD TRANSFORMER 上，使左右固定翼插入左右扶手下面与坐垫形成的两个槽中。

将护体往后推，直至固定翼 (P3) 接触/靠近位于左右扶手下方的红色标记。

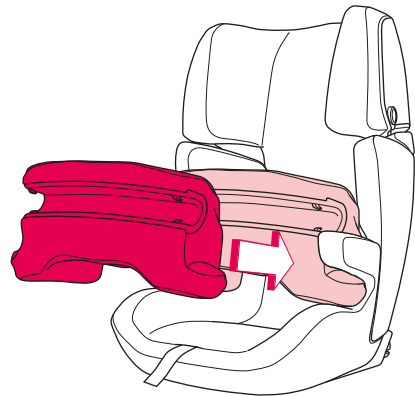

注意！

- 确保固定翼 (P3) 安装于CONCORD TRANSFORMER上的正确位置！
- CONCORD 护体不得歪斜或反向装配。

将成人安全带的腰带及肩带绕过CONCORD 护体至成人安全带的带扣，然后扣上成人安全带。（“嗒”一声说明扣好。）

正确调整成人安全带。

成人安全带的腰带及肩带都要经过安全带导向槽的(P2) 两侧，按照右图的方法将安全带固定在挡点(P1) 上。

其它部分的成人安全带肩带，要绕过儿童安全座椅护肩的前部边缘，腰带经过CONCORD TRANSFORMER的扶手上方。

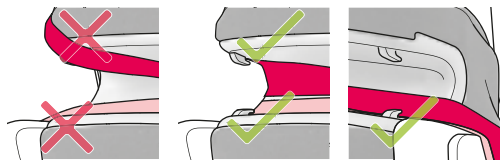

安全带不得以其他方式安装。

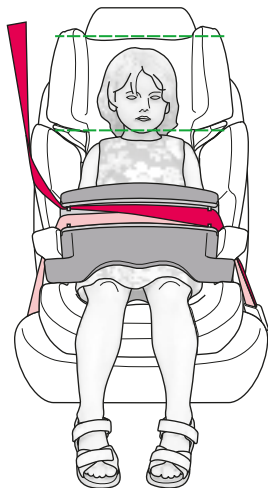

注意!

- 成人安全带导向槽内的成人安全带，必须被牢固地扣在挡点(P1)内。
- 使用CONCORD 护体时，务必根据儿童体型，使用CONCORD TRANSFORMER 上的尺寸调节装置调整座椅!
- 首先拉紧安全腰带，然后是肩带。
- 确保安全带松紧舒适，不得扭曲。

_ CONCORD 护体的护理

面套可以拆下来清洗。重新安装前，面套必须晾干!

在CONCORD 护体上安装面套时，首先将护体泡沫支架装入面套内，然后将面套边缘塞入安全带导向槽(P2)周围的固定槽中。

- 受潮尤其是清洗后布套可能会轻微褪色。
- 请勿使用溶剂。



使用三点式安全带保护儿童（适用15至36公斤）

让儿童尽量座在车辆座椅靠后的位置。成人安全带绕过儿童正面，到达成人安全带带扣，然后扣好成人安全带（必须听到咔嚓声）。

现在调整安全带。让腰部安全带经过两侧的成人安全带腰带导向标识，车辆安全带带扣一侧的斜拉安全带，要通过同侧的成人安全带腰带导向标识位置(03)。

最后，让肩部安全带穿过成人安全带肩带导向机构(06)。

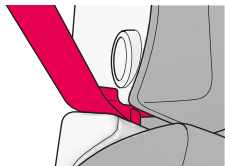

肩带必须推入肩部导向机构里面，被锁扣锁住。

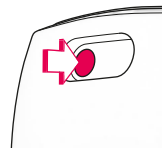

按儿童体型调整CONCORD TRANSFORMER时，轻轻下压头枕(01)。再按靠背后面的尺寸调整按钮(04)，按住按钮的同时将头枕(01)上升或下压到需要的位置。

CONCORD TRANSFORMER 的尺寸可以无级调节，释放调整按钮(04)后，当前位置将被锁定。

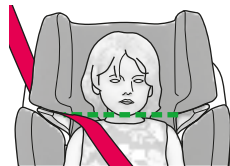
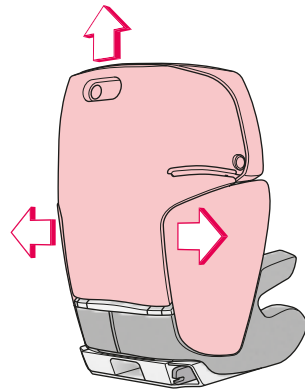

成人安全带肩带导向机构(06)应略高于儿童肩膀顶部。同时，肩部安全带应通过儿童颈侧与肩部外缘之间的中间位置。

儿童约束系统的每条与车辆连接的织带应系紧，约束儿童的织带应根据儿童的身体进行调整，织带不得扭曲。成人安全带的腰带要尽量放低。如果你的汽车配备了成人安全带高度调节器，可相应调整其高度。

想让孩子离开儿童安全座椅，只需打开带扣，使约束孩子的安全带缩回就可以了。要从导向机构上取下肩部安全带，按下肩带导向机构按钮(05)，向前将安全带拉出。

每次使用儿童安全座椅时一定要确保成人安全带正确安装。安装方面如有任何疑问，请与CONCORD联系。安全带必须经过座椅上红色标记的导向标识。不得选择其他方式安装安全带。

_ 基本说明

- 这是“通用类”儿童约束系统，符合GB27887-2011，及ECE R44/04 标准。作为通用类儿童约束系统，适合大多数，而不是全部的汽车座椅。
- ECE类别I、II和III的儿童约束系统适合于9个月至12岁体重9-36公斤的儿童。
- 如果汽车制造商在使用手册中注明可以让适用此年龄段的“通用类”儿童约束系统配合的话，那么更容易达到正确的匹配。
- 如有疑问，请咨询儿童约束系统制造商或零售商。
- 只有在适用车型配备了通过GB14166或ECE R16 要求的3点式安全带情况下才适用。

面套护理

面套可以拆下来清洗。

首先，要将头枕(01)升至最高处。然后，解开面套与主体的连接点。移除面套的顺序：先移除头枕部分(01)，然后是座垫部分，再是护肩部分(02)。

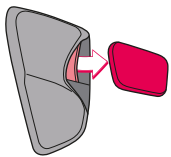

清洗前，要先卸除面套护肩部分(02)的泡沫塑料。

- 受潮尤其是清洗后，面套面料可能会轻微褪色。
- 请勿使用溶剂！

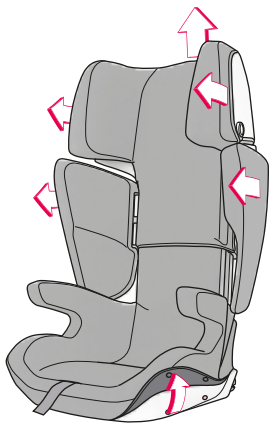

重装面套时，应从座垫部分开始。首先，将面套套在靠背的罩板上，然后从前面将其罩到扶手和座椅上。接着将面套固定在各连接点上。

再安装面套的头枕部分(01)。

将有标识的泡沫塑料放进护肩(02)面套对应标识的插袋内。然后将面套用护肩部分(02)。

面套和泡沫塑料不得装反，装错。

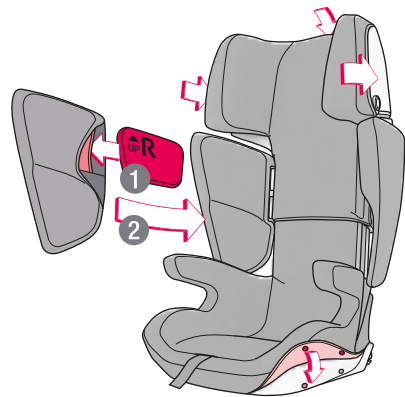

_ 保修

保修自购买当日生效。

保修期时限遵照本产品各最终消费国的法定期限。保修内容包括修理、更换零件及折价，具体由制造商视情形而定。

原始购买用户方可享受保修。产品如发生损坏，应于第一时间通知经销商，经销商认定后方可享受保修。若该问题无法由经销商解决，则由经销商将产品连同详细故障说明及标明购买日期的正规购买凭证寄回制造商处。制造商对于非其提供的产品出现的损坏恕不承担责任。

发生以下情形时，保修将失效：

- 产品经过改装。
- 产品出现问题后未在14天内将产品连同购买凭证送至经销商处。
- 由于用户操作或保养不当，或其它方面的失误，特别是因未遵守使用说明书的规定而造成的产品损坏。
- 产品由第三方进行维修。
- 由于事故产生的损坏。
- 序列号已被损毁。

由于正常使用导致的产品正常的状态改变或折旧（磨损）均不在保修之列。制造商若在保修期内进行维修，保修期并不因此而延长。

_ CONCORD原装备件/附件

有关Concord原装备件/附件的信息可直接向零售商或Concord索取。

Concord GmbH

德国，施塔特施泰纳赫，工业路25号

电话：+49 (0) 9225. 9550-0

传真：+49 (0) 9225. 9550-55

电子邮件：info@concord.de

公司网址：www.concord.de

_ ENGLISH

OVERVIEW	30
THANK YOU!	32
NOTES	32
USING THE CONCORD TRANSFORMER PRO	36
INSTALLING THE CONCORD TRANSFORMER	37
INSTALLING THE CONCORD TRANSFORMER WITH TWINFIX	38
REMOVING THE CONCORD TRANSFORMER WITH TWINFIX	40
VEHICLES SUITABLE FOR TWINFIX	41
USING THE CONCORD PROTECTOR (FROM 9 TO 18 KG)	42
CARE INSTRUCTIONS CONCORD PROTECTOR	45
SECURING THE CHILD WITH THE THREE-POINT BELT (FROM 15 TO 36 KG)	46
GENERAL INFORMATION	49
CARE INSTRUCTIONS	50
GUARANTEE	52
CONCORD ORIGINAL SPARE PARTS/ACCESSORIES	54

_ OVERVIEW

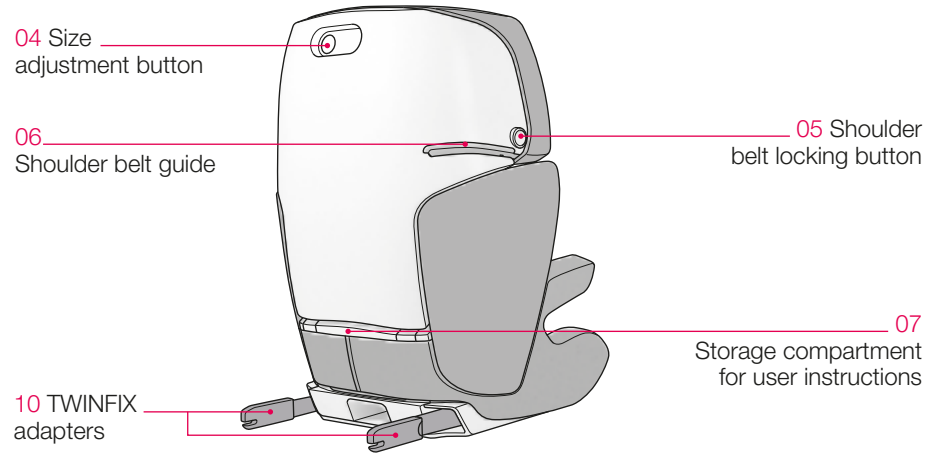
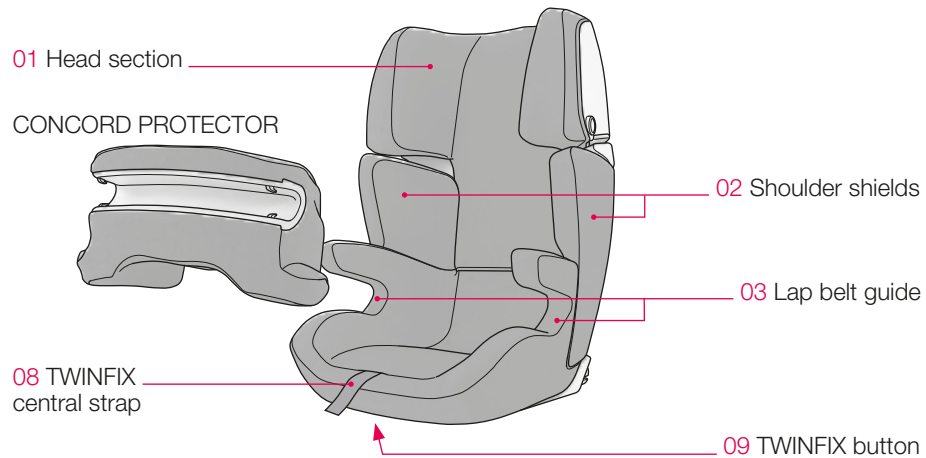

_ **THANK YOU!**

We are delighted that you have chosen a quality Concord product. You are sure to be convinced by this product's versatility and safety. We hope you enjoy using your new CONCORD TRANSFORMER PRO.

_ **NOTES**

ATTENTION!

- Please read the instructions for use thoroughly before using the CONCORD TRANSFORMER PRO and keep them carefully for later reference. Not following the instructions described herein can put the safety of the child at risk! Please also note the instructions in the car's operating manual for transporting children in a car.

WARNING!

- Do not leave your child unattended.
- Children sometimes have items in their jacket or trouser pockets (e.g. toy) or wear hard items that are attached to their clothes (e.g. belt buckle). Make sure that these items do not get between the child and the safety belt – they could cause unnecessary injuries in the event of an accident. These hazards also apply to adults!
- Naturally children can often be very lively. You should therefore explain to children how important it is to always be safely fastened in. Children must understand that they should never change the way the belts are positioned, and never open the buckle.
- Only if safety equipment is correctly installed and used can your child enjoy maximum safety.
- The system straps must be fitted tautly and without twists and must be protected against damage.
- Protect those parts of the CONCORD TRANSFORMER PRO that are not covered in fabric from direct sunlight to avoid your child being burned.
- The child restraint system must not be damaged or trapped by moving parts in the car interior or by doors.
- Never modify the CONCORD TRANSFORMER PRO in any way – this will endanger your child's safety.

- After an accident the CONCORD TRANSFORMER PRO must be replaced or returned to the manufacturer for testing, along with a report of the accident.
- You should also tell your passenger how to remove the child in the event of an accident or danger.
- Do not leave your child in the child car seat unsupervised whether strapped in or not.
- Secure luggage and other items to reduce the risk of injury in the event of an accident.
- The user instructions must always accompany the child car seat.
- The use of accessories and replacement parts is not permissible and shall lead, in the event of contravention, to the expiry of all claims under the warranty and of all liability claims. Only special CONCORD original accessories are excluded.
- Suitable for cars with three-point (lap and diagonal) seat belts tested in accordance with ECE Regulation 16 or a comparable standard.

As the period of use for the CONCORD TRANSFORMER PRO is very long, it is natural that seat covers and other used parts will each receive different degrees of wear and tear depending on the individual duration and intensity of use and will need to be replaced.

For this reason it is not possible to give a blanket warranty of durability extending beyond a six-month warranty period. For additional purchases, please contact your local specialist child and baby shop, specialist departments in department stores, a car accessories centre or mail order companies. There you will also be able to buy the full range of accessories for CONCORD child car seats.

The buckle of the vehicle safety belt must not come above the edge of the lap belt guide. If in doubt or if you are still uncertain, please contact CONCORD. The belts may only be routed via the points of contact and the positions on the seat stated in the user instructions. Belts must not be routed in any other way.

If the car seat used has a front airbag, we recommend positioning the car seat as far back as possible. For cars with front and side airbags, the instructions in the car's operating manual must also be observed. The car's shoulder/diagonal belt must pass forwards from the vehicle bracket to the shoulder belt guide (06). Adjust the car seat position if necessary.

_ USING THE CONCORD TRANSFORMER PRO

You have decided to purchase our CONCORD TRANSFORMER PRO seat for the safety of your child. This product is manufactured under strict quality controls. It can only effectuate its maximum safety properties if it is used properly. The cover is an important component and contributes to the seat's effectiveness; for this reason the seat must only be used with its original cover! You should therefore ensure that you follow the instructions for fitting and use carefully.

The seat may be used on any seat in your car that is fitted with a three-point seat belt. Statistics suggest that the place behind the passenger seat is the safest in the car.

_ INSTALLING THE CONCORD TRANSFORMER

Place the CONCORD TRANSFORMER on the car seat or bench seat, facing in the direction of travel. The CONCORD TRANSFORMER should lie flush with the seat. In cars with standard headrests, these may be adjusted or removed to make it easier to install the child car seat.

Please note that the car headrests must be replaced and re-positioned correctly when an adult is travelling in the car.

The seat may not be transported unsecured in the vehicle, even if there is no child passenger. Otherwise passengers risk injury during the journey or in the event of an accident. For this reason, the belt must always be fastened when travelling.

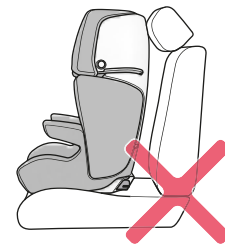

_ INSTALLING THE CONCORD TRANSFORMER WITH TWINFIX

Push the TWINFIX button (09) down and simultaneously pull out the TWINFIX adapters (10) on the back of the child seat to their full extent.

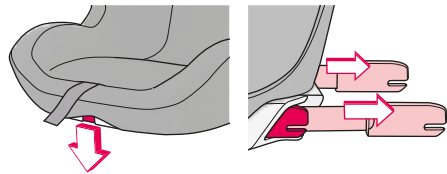

Position the CONCORD TRANSFORMER facing forwards on the vehicle seat or bench fitted with ISOFIX points.

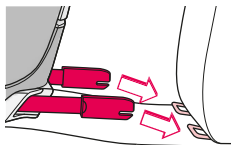

Push both TWINFIX adapters (10) on to the ISOFIX points in the vehicle until the locking mechanisms have clicked audibly into place.

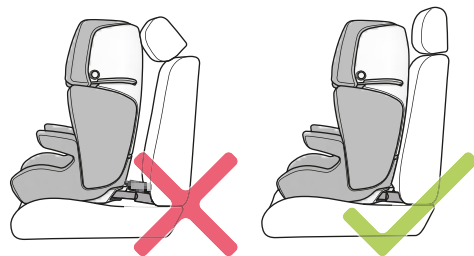
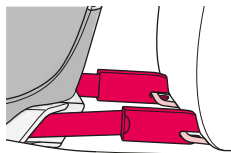

Pull the TWINFIX central strap (08) forwards and guide the CONCORD TRANSFORMER back until it lies as close/flush as possible to the car seat backrest.

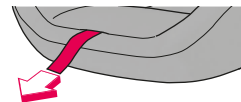

In cars with standard headrests, these may be adjusted or removed to make it easier to install the child car seat. Please note that the car headrests must be replaced and re-positioned correctly when an adult is travelling in the car.

ATTENTION!

- TWINFIX is an additional fitting system for securing the CONCORD TRANSFORMER and is not suitable for securing a child.
- Children must always be secured by means of the car's three-point safety belt.

_ REMOVING THE CONCORD TRANSFORMER WITH TWINFIX

To remove the CONCORD TRANSFORMER, press the TWINFIX button (09) down and move the seat fully forwards.

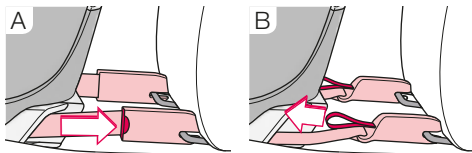

Now open the lock of the TWINFIX adapters (10) so that the safety hooks open and the adapters pop out.

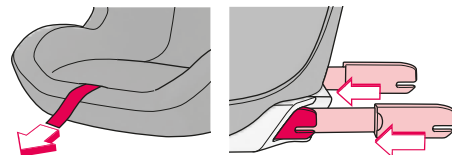

Pull the TWINFIX central strap (08) forwards until the TWINFIX adapters (10) are fully retracted!

You can also push the TWINFIX adapters (10) further into the seat by hand!

_ VEHICLES SUITABLE FOR TWINFIX

The CONCORD TRANSFORMER with CONCORD TWINFIX system has been certified for “semi-universal” use and is suitable for installation on the seats of specified vehicles.

Please refer to the additional “CAR FITTING LIST” leaflet for an overview of cars and vehicle seats compatible with the CONCORD TWINFIX system at the time your child seat was manufactured.

For a continuously updated version, please visit www.concord.de.

_ USING THE CONCORD PROTECTOR (FROM 9 TO 18 KG)

P1 Attachment hooks

P2 Harness guide

P3 Stabilisers

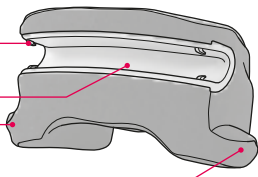

WARNING!

- The CONCORD PROTECTOR may only be used in conjunction with the CONCORD TRANSFORMER PRO.
- The CONCORD TRANSFORMER PRO can be used without the CONCORD PROTECTOR, once the child has reached about 4 years of age or approx. 15 kg body weight.

Mount the CONCORD TRANSFORMER on the vehicle seat as described in the user manual.

Place your child onto the seat of the CONCORD TRANSFORMER as far back as possible.

Place the CONCORD PROTECTOR onto the CONCORD TRANSFORMER so that the stabilisers (P3) are level with the harness guides (03) of the CONCORD TRANSFORMER.

Push the restraining body backwards until the stabilisers (P3) are flush with the red markings on the harness guide.

CAUTION!

- Ensure that the stabilisers (P3) are positioned correctly in the harness guides (03) of the CONCORD TRANSFORMER!
- The CONCORD PROTECTOR must not be attached at an angle, askew or back to front!

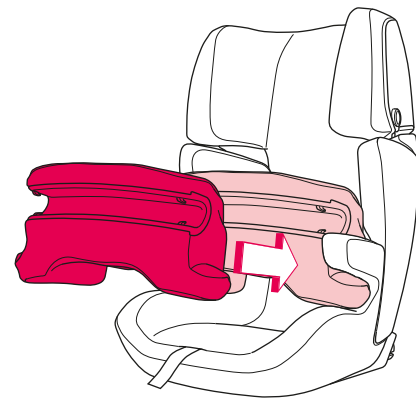

Run the lap and diagonal belt from the CONCORD PROTECTOR to the lock and close the seat belt as with an adult. (An audible click will signal proper locking.)

Now position the seat belts correctly.

Run the lap and diagonal seat belts through the harness guide (P2) on both sides. Hook the seat belts into the attachment hooks (P1).

The diagonal belt will run along the front edge of the side protector, and the lap belt over the arm rests of the CONCORD TRANSFORMER.

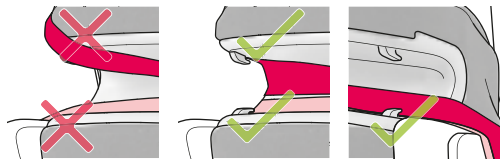

The seat belt must not be laid out in any other way.

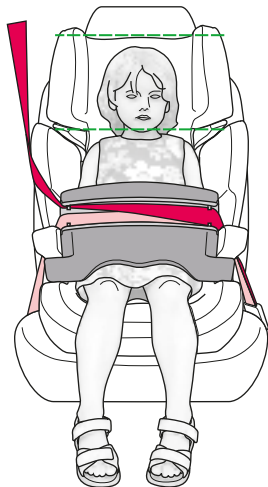

CAUTION!

- The seat belts must be positioned securely behind the attachment hooks (P1)!
- You must always use the size adjustment on the CONCORD TRANSFORMER to adapt the seat to the size of the child, when using the CONCORD PROTECTOR!
- Tighten first the lap belt and then the diagonal belt.
- Ensure that the seat belts are snug and not twisted.

_ CARE INSTRUCTIONS CONCORD PROTECTOR

The cover can be removed for washing.

Make sure to leave the cover to dry completely, before reattaching it!

When attaching the cover on the CONCORD PROTECTOR, pull it over the top of the unit and tuck the surrounding groove at the harness guide (P2).

- The cover material colour may run slightly when wet, in particular during washing.
- Do not use solvents on the cover!



SECURING THE CHILD WITH THE THREE-POINT BELT (FROM 15 TO 36 KG)

Seat your child well back in the seating area. Pass the three-point belt across the front of the child to the seat belt lock, and fasten it in the same way as for an adult. (There must be an audible click.)

Now position the belts. Pass the lap belt across both sides and the diagonal belt on the side of the seat belt lock through the lap belt guide (03). Finally, pass the diagonal belt through the provided shoulder belt guide (06).

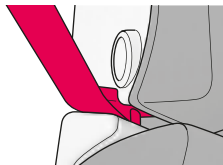

Make sure the belt passes inside the securing hook.

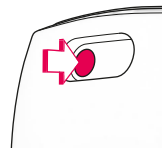

To adjust the CONCORD TRANSFORMER to the size of the child, gently press the head section (01) down. Now press the size adjustment button (04) on the back of the backrest and keep it

pressed whilst moving the head section (01) into the required position. The CONCORD TRANSFORMER can be continuously adjusted to the right size and is locked into the current position when the adjustment button (04) is released.

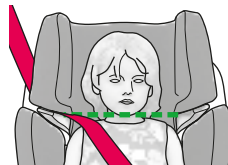
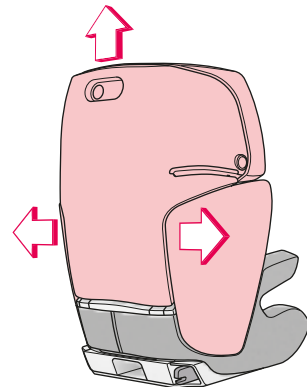

The shoulder belt guide (06) should be slightly above the top of the child's shoulder. At the same time, the shoulder belt should pass centrally between the child's neck and the outer edge of the shoulder.

Pull the belt taut so that the lap belt and diagonal belt are well positioned and ensure that the belts are not twisted. The lap belt should be in the lowest possible position. If your vehicle is fitted with a seat belt height adjuster, adjust its height accordingly.

When you wish to release the child from the seat, all you need to do is open the lock and pass the strap back across the child. To remove the shoulder belt from the guide, press the shoulder belt locking button (05) and pull the belt forwards and out.

It is important to ensure that the belts are always correctly positioned each time the seat is used. If in doubt about any aspect of fitting, check with CONCORD.

The belts must pass through the guides marked in red on the seat. Belts must not be routed in any other way.

– GENERAL INFORMATION

- This is a “universal” child restraint system. It is approved for general use in vehicles in accordance with ECE Regulation 44, Amendment 04 and fits most, but not all, passenger vehicle seats.
- This child restraint system from ECE groups I, II and III is suitable for children from 9 months – 12 years weighing 9 – 36 kg.
- It can be assumed that the system will fit correctly if the vehicle manufacturer states in the vehicle manual that the vehicle is suitable for the installation of a “universal” child restraint system for the relevant age group.
- This child restraint system has been classified as being of the “universal” class, satisfying stricter conditions than previous models which do not bear this label.
- If in doubt, please consult the manufacturer of the child restraint system or the retailer.
- Only suitable for vehicles with three-point (lap and diagonal) seat belts tested and approved in accordance with ECE Regulation 16 or a comparable standard.

_ CARE INSTRUCTIONS

The cover can be removed for washing. To do so, move the head section (01) to its highest position. To remove, pull the cover away from its anchoring points. Begin by removing the head section (01) followed by the seat section and the shoulder shields (02).

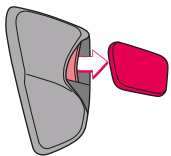

Remove the styrofoam parts from the covers in the shoulder area (02) before washing.

- When they come into contact with moisture, especially during washing, the cover fabrics may fade slightly.
- Do not use solvents!

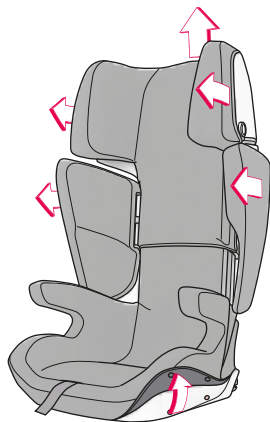

To replace, start with the cover for the seat section. Firstly, pull the cover over the cover panel on the backrest, and then, from the front, pull it over the armrests and seat section.

Secure the cover using all of the fastening points.

Attach the cover for the head section (01).

Place the matching styrofoam parts into the marked pocket on the inside of the covers for the shoulder area (02). Now pull the covers over the protectors for the shoulder area (02).

The covers and styrofoam parts must not be reversed!

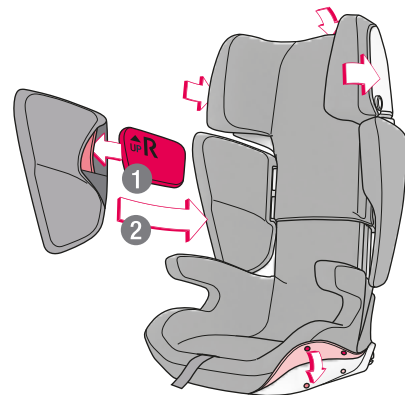

_ GUARANTEE

The guarantee begins on the day of purchase. The guarantee period corresponds to the statutory warranty period in the end-user's country concerned. At the manufacturer's discretion, the guarantee shall cover rectification, replacement or a price reduction.

The guarantee is valid for the original purchaser only. In the event of any defect, claims can not be considered unless the specialist dealer is notified of the fault as soon as it occurs for the first time. If the specialist dealer is unable to remedy the problem himself, he must return the product to the manufacturers together with details of the complaint, official proof of purchase and the purchase date. The manufacturers assume no liability for faulty goods that they did not supply.

The guarantee does not apply where:

- the product has been modified;
- the product is not brought back to the specialist dealer complete with proof of purchase within 14 days of the defect occurring;
- the defect was caused by improper usage or maintenance or due to anything else deemed to be the fault of the user, in particular failure to comply with the instructions for use;
- repairs have been carried out on the product by third parties;
- the defect was caused as the result of an accident.
- the serial number has been damaged or removed

The guarantee makes no provision for any alteration or deterioration to the product that is incurred through normal usage (wear and tear). The period of guarantee shall not be extended by any remedial measures carried out by the manufacturers in the event of a claim.

_ CONCORD ORIGINAL SPARE PARTS/ACCESSORIES

Information on Concord original spare parts/accessories is available at your retailer's or directly from Concord.

Concord GmbH
Industriestraße 25
95346 Stadtsteinach
Germany

Phone +49 (0)9225.9550-0
Fax +49 (0)9225.9550-55
info@concord.de

www.concord.de

_ 中文
_ **ENGLISH**

安装和操作说明

Instructions for attachment and use

制造商

Concord GmbH

地址：德国，施塔特施泰纳赫，工业路25号

Address: Industriestraße 25, 95346 Stadtsteinach, Germany

电话 / Phone: +49 (0)9225.9550-0

传真 / Fax: +49 (0)9225.9550-55

邮箱 / E-mail: info@concord.de

网址 / URL: www.concord.de

TRPRO 02/0812 . IM 1759 ,00

